

# Befestigung FI-10-ZM-W

Ref. C28116N00

Ref. arch 42242

- Längsaufhängung am Stab oder am Seil
- Kleine Abmessungen

## ZWECK DES PRODUKTS

- zum Aufhängen von LED-Leuchten

## INSTALLATION

- am Stab oder Kabel, mit einem Druckbolzen
- mit einer Druckschraube am Stab



## TECHNISCHE ZEICHNUNG

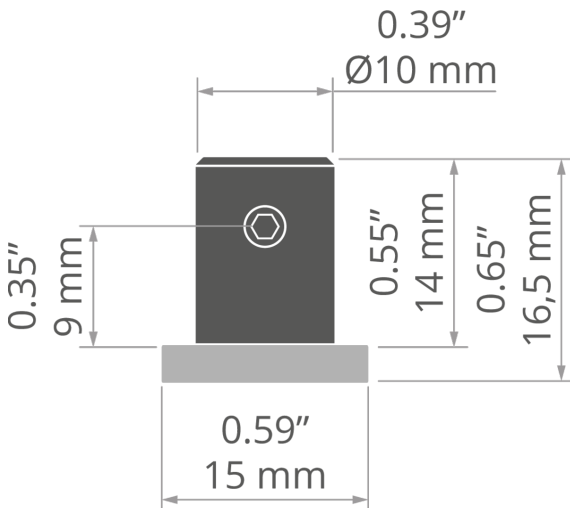

## TECHNISCHE SPEZIFIKATIONEN

Material	rostfreier Stahl	Höhe	16.5 mm
Farbe	silbern	Durchmesser	10 mm
Breite	15 mm	Tragfähigkeit	30 kg

# Befestigung FI-10-ZM-W

Ref. C28116N00

Ref. arch 42242

## VERWANDTE PROFILE > ARCHITEKTONISCH



**3035**  
A18039  
Ref. arch 18039

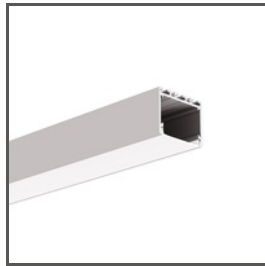

**3035-O**  
A08441  
Ref. arch B8441

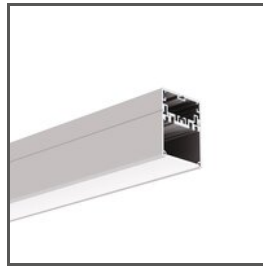

**4050**  
A18050  
Ref. arch 18050

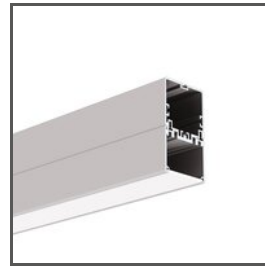

**4050-W**  
A18051  
Ref. arch 18051



**GIZA**  
A05556  
Ref. arch B5556



**GIZA-DUO-LL**  
A02162  
Ref. arch C2162



**GIZA-LL**  
A00758  
Ref. arch C0758

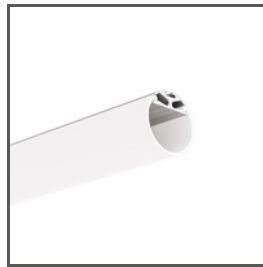

**JAZ**  
A08547  
Ref. arch B8547

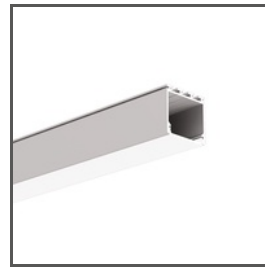

**LIPOD**  
A05554  
Ref. arch B5554



**OPK-4**  
A00370  
Ref. arch C0370

## VERWANDTE PROFILE > FÜR HAUPTBELEUCHTUNG



**LIPOD-50**  
A02609  
Ref. arch C2609

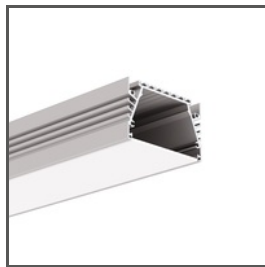

**SEPOD**  
A06593  
Ref. arch B6593

## VERWANDTE PROFILE > MINIMALISTISCH



**PIKO-ZM**  
A01168  
Ref. arch C1168

## VERWANDTE PROFILE > UNIVERSAL

# Befestigung FI-10-ZM-W

Ref. C28116N00

Ref. arch 42242



## OLEK

A08505

Ref. arch B8505



## PDS-ZM-PLUS

A02056

Ref. arch C2056

### VERWANDTE SYSTEME > FÜR ALLGEMEINBELEUCHTUNG

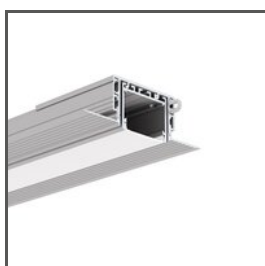

## 3035-KOZE

A08441+A18056

Ref. arch 18056+B8441



## PK-4

A18044+A00370

Ref. arch 18044+C0370

### PASSENDES ZUBEHÖR > ANDERE > SEILE UND STÄBE

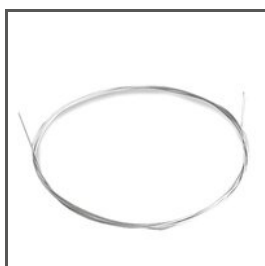

LINKA STALOWA

## FI-1 1m

C24522N00

Ref. arch 1397

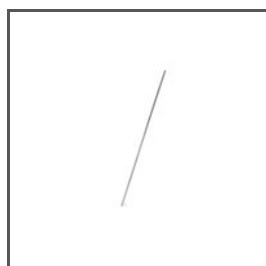

STAB

## FI-3 1m

42501

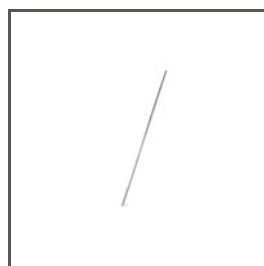

STAB

## 100 PUSZ 1 m

42518

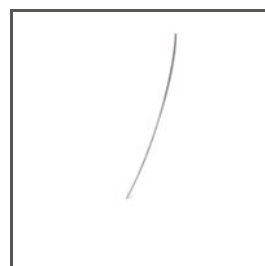

STAB

## FI-3 53 cm

C24528N00

Ref. arch 1528

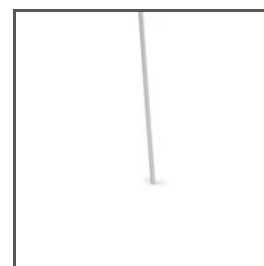

STAB

## FI-3-ALU

C28196A01, C28196A07

Ref. arch 42526, 42527, 42528, 42529