



- Montage auf Gipskartonplatten
- Unsichtbare Einlasskante

### ZWECK DES PRODUKTS

- Hauptbeleuchtung und dekorative Beleuchtung

### INSTALLATION

- in Einlässen, mit speziellem Zubehör
- einfach zu Strängen und Systemen kombinierbar

### ZUSÄTZLICHE INFORMATION

- Standardlängen von KLUŚ Profilen und Abdeckungen: 1000mm (Toleranz ± 1,5mm) und 2005mm / 3010mm (Toleranz +5mm); für ausgewählte Abdeckungen 6050mm, 10050mm (Toleranz +5mm)
- Bei der Auswahl einer nicht standardmäßigen Länge der Profile / Abdeckungen sollten Sie den Zuschnittservice bei KLUŚ dazuwählen

### TECHNISCHE ZEICHNUNG

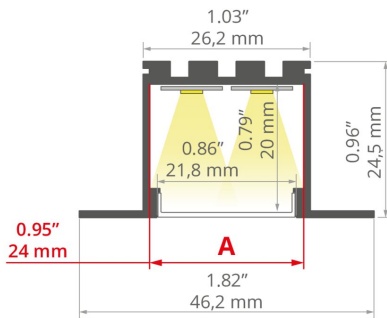

### TECHNISCHE SPEZIFIKATIONEN

Material	Aluminium
Mögliche IP der Leuchte	20, 65
Mögliche Formen der Leuchte	polygonal
Profilquerschnitt	rechteckiger
Breite	46.2 mm
Höhe	24.5 mm
LED-Klebebreite A	24 mm
Anzahl LED-Streifen A (8 mm breit)	2
Lichtlinienfähig	ja
Gebäudetyp	HoReCa-Anlage, Kommerzielles Gebäude, Handelsgebäude
Einrichtungszone	Nische, Wandbeleuchtung, Büro, Möbel, Verkehrswege
Abdeckung zugeschnitten auf die Profillänge	ja
Möglichkeit der einfachen Verbindung zu Strängen	ja
Für GK-Platten	ja
Kabelführung von unten	ja

Farbe	Länge	Ref
■ silbern eloxiert	1000 mm	A05552A_1 B5552ANODA_1
	2005 mm	A05552A_2 B5552ANODA_2
	3010 mm	A05552A_3 B5552ANODA_3
□ weiß lackiert	2005 mm	A05552L10OD_2 B5552L9010OD_2
	1000 mm	A05552L10OD_1 B5552L9010OD_1
	3010 mm	A05552L10OD_3 B5552L9010OD_3

# Profil LARKO

Ref. A05552



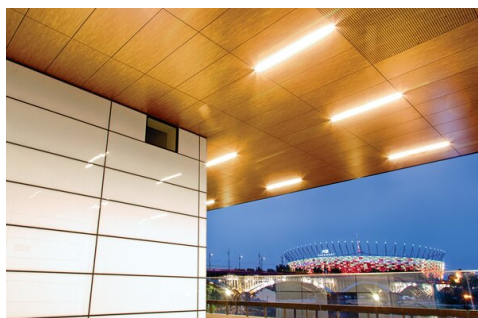
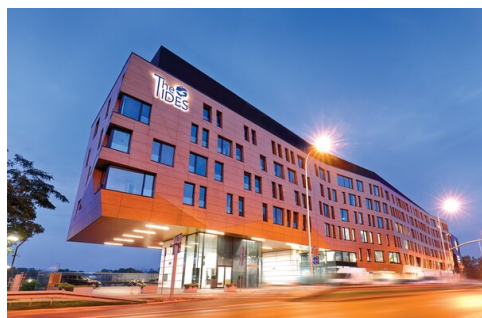

Ref. arch B5552

**KLUŚ** Inspiring  
Solutions

## BEISPIELPROJEKTE



## PASSENDEN ZUBEHÖR > ABDECKUNGEN

NAME	MATERIAL	LICHTDURCHLÄSSIGKEITFARBE	REF.
LIGER-22		PC	62 % <input type="checkbox"/> milchige B17032M 17032V1
			B17032M 17032V1OP
			39 % <input checked="" type="checkbox"/> schwarz B17032C 17087
HS-22		PC	73 % <input type="checkbox"/> milchige B17011M 17011
			94 % <input checked="" type="checkbox"/> transparente B17011T 17022
			G-K
B17204F 00415			
72 % <input type="checkbox"/> milchige B17013M 17013			
24 % <input checked="" type="checkbox"/> schwarz B17013C 17014			
47 % <input type="checkbox"/> milchige B17203M 00413			
G-L		PMMA	69 % <input type="checkbox"/> milchige B17006M 17010
			17008 17008
			85 % <input checked="" type="checkbox"/> mattierte 95 % <input checked="" type="checkbox"/> transparente B17006T 17006
			85 % <input checked="" type="checkbox"/> mattierte B17006F 17017
			17008 17008
			95 % <input checked="" type="checkbox"/> transparente B17006T 17006
			30 % <input checked="" type="checkbox"/> schwarz B17006C 17012
MUN-22		PC	86 % <input checked="" type="checkbox"/> mattierte B17042F 17042

## PASSENDEN ZUBEHÖR > ENDKAPPEN

NAME	MATERIAL	FARBE	REF.
LARKO		<input checked="" type="checkbox"/> grau C24006C02 24006	
		<input checked="" type="checkbox"/> metallisiert C24006L01 24102	
		<input type="checkbox"/> weiß C24006C10 24410	

### PASSENDEN ZUBEHÖR > RELATED LED

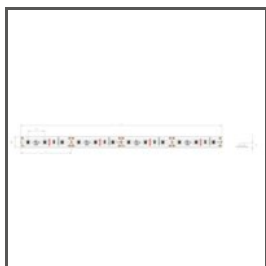

**K-1210-12V**

K-1210-12  
Ref. arch K-1210-12V



**K-1275-12V**

K-1275-12  
Ref. arch K-1275-12V



**WP-K-1220-12V**

KWP-1220-12  
Ref. arch WP-K-1220-12V

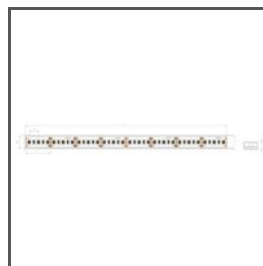

**WP-K-1275-12V**

KWP-1275-12  
Ref. arch WP-K-1275-12V



**WP-K-1220-IP65-12V**

\_błąd  
Ref. arch WP-K-1220-IP65-12V

### PASSENDEN ZUBEHÖR > RELATED LED > HÖHE EFFIZIENZ

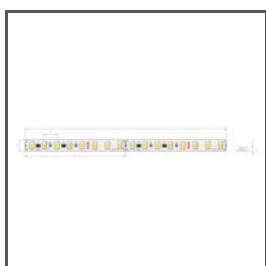

**K-HE-0480-HD-24V**

K-HEHD-0480-24  
Ref. arch K-HE-0480-HD-24V



**K-HE-0960-HD-24V**

K-HEHD-0960-24  
Ref. arch K-HE-0960-HD-24V

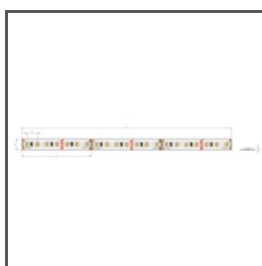

**K-HE-1440-HD-24V**

K-HEHD-1440-24  
Ref. arch K-HE-1440-HD-24V

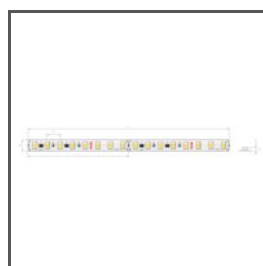

**K-HE-1920-HD-24V**

K-HEHD-1920-24  
Ref. arch K-HE-1920-HD-24V

### PASSENDEN ZUBEHÖR > RELATED LED > MONOWEISS



**WP-K-1640-HD-IP65-24V**

KWP-GHD-1640-24  
Ref. arch WP-K-1640-HD-IP65-24V



**WP-K-1910-HD-IP65-24V**

KWP-GHD-1910-24  
Ref. arch WP-K-1910HDIP6524V



**WP-K-1220-IP65-24V**

KWP-1220-IP65-24  
Ref. arch WP-K-1220-IP65-24V

### PASSENDEN ZUBEHÖR > RELATED LED > RGB / RGB-W / RGB-CTT



**K-1530-RGB+W-24V**

K-RGBW-1530-24  
Ref. arch K-1530-RGB+W-24V



**WP-K-1530-RGB+W-24V**

KWP-RGBW-1530-24  
Ref. arch WP-K-1530-RGB+W-24V

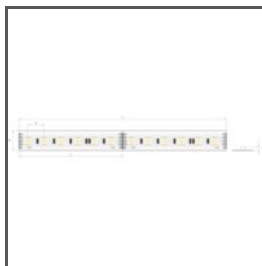

**K-1920-120-RGB-24V**

K-RGB-1920-120-24  
Ref. arch K-1920-120-RGB-24V

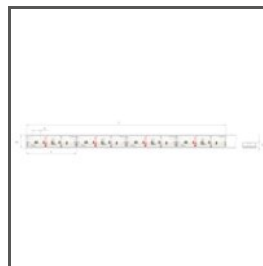

**WP-K-1920-120-RGB-24V**

KWP-1920-120-RGB-24  
Ref. arch WP-K-1920-120-RGB-24V

## PASSENDES ZUBEHÖR > ANDERE > EINRASTEN



EINRASTER

**TEKNIK**

C24003C10

Ref. arch 24003

## PASSENDES ZUBEHÖR > ANDERE > FEDERN FÜR NUTEN UND TECHNISCHE PROFILE

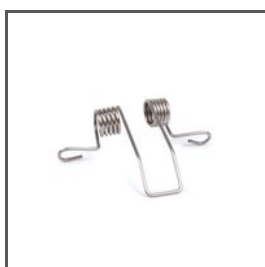

FEDER

**KMA**

C24503N00

Ref. arch 00838

## PASSENDES ZUBEHÖR > ANDERE > FORMSTÜCKE

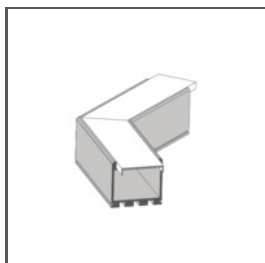

FORMSTÜCK

**L135**

L135

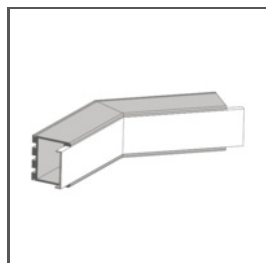

FORMSTÜCK

**L135PW**

L135PW

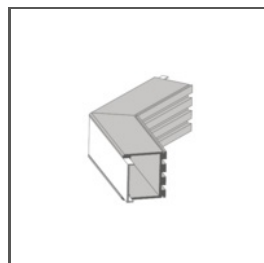

FORMSTÜCK

**L135PZ**

L135PZ

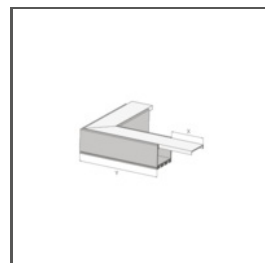

FORMSTÜCK

**L90**

L90

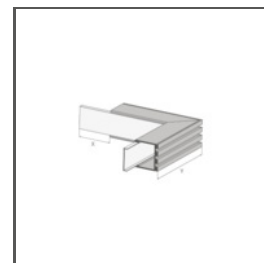

FORMSTÜCK

**L90PW**

L90PW

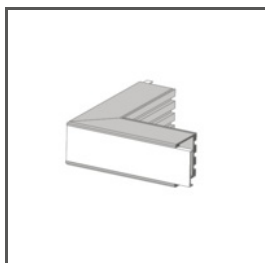

FORMSTÜCK

**L90PZ**

L90PZ

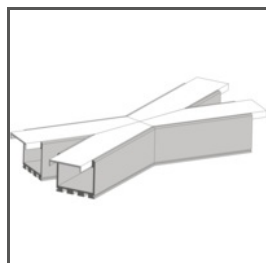

FORMSTÜCK

**X135**

X135

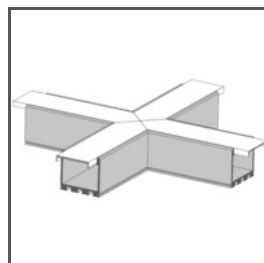

FORMSTÜCK

**X90**

X90

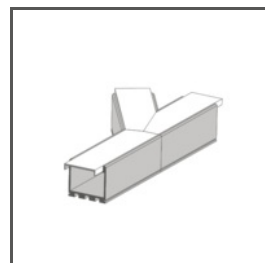

FORMSTÜCK

**T135L**

T135L

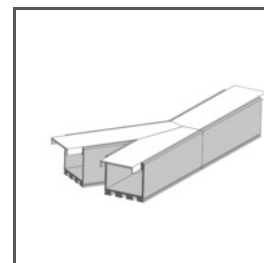

FORMSTÜCK

**T135R**

T135R

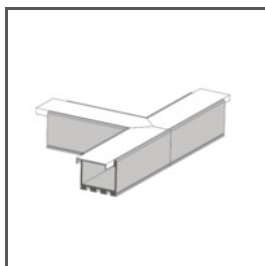

FORMSTÜCK

**T90**

T90

---

## PASSENDES ZUBEHÖR > ANDERE > PROFILBLENDEN



BEFESTIGUNGSBLENDE

**MP-22**

C28261L01\_0.25,

C28261L10\_0.25,

C28261L07\_0.25

Ref. arch 17167, 17167L9010,  
17167L9005

---

## PASSENDES ZUBEHÖR > ANDERE > SONSTIGE



KABELVERSCHRAUBUNG

**6,4x3**

C42264C07

Ref. arch 42264

---

## PASSENDES ZUBEHÖR > ANDERE > STROMFÜHRENDE BEFESTIGUNGEN UND KÖPFE FÜR PROFILE

# Profil LARKO

Ref. A05552

Ref. arch B5552



BEFESTIGUNG

**OS22-LIN-Z**

C28184L07, C28184L10

Ref. arch 42341L9005, 42341L9010



BEFESTIGUNG

**OS22-PRET-Z**

C28186L07, C28186L10

Ref. arch 42344L9005, 42344L9010



BEFESTIGUNG

**OS22-DUO-LIN-Z**

C28183L07, C28183L10

Ref. arch 42340L9005, 42340L9010



BEFESTIGUNG

**OS22-DUO-PRET-Z**

C28185L07, 42343L9010

Ref. arch 42343L9005, 42343L9010

## PASSENDES ZUBEHÖR > ANDERE > VERBINDUNGSTÜCKE



VERBINDUNGSTÜCK

**ZM-180**

C28075N00

Ref. arch 40693